



# SERRA

Serratura di altissima sicurezza a doppia mappa ad infilare per serramenti e cancelletti, chiusure laterali e triplici.

*High security double ward locks for frames and gates.  
Lateral and triple closings.*





ATTURBE

serrature ad

infilare

mortice locks







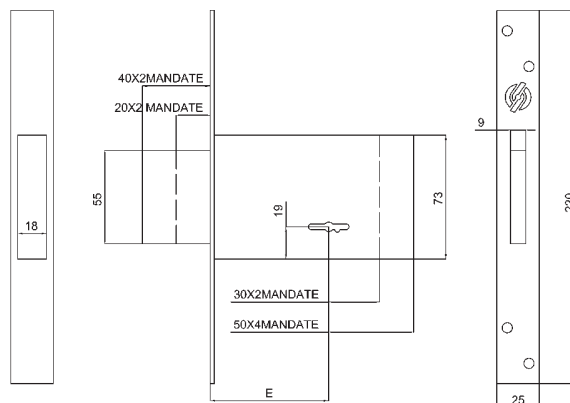
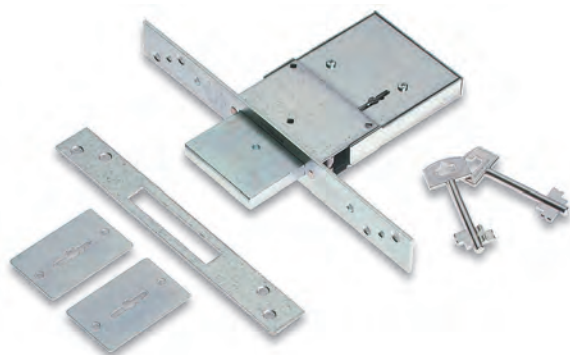

Serratura laterale a doppia mappa per serramenti e cancelletti. E. 50 - 60 - 70 mm. Finitura zincata.

Lateral double ward lock for frames and gates. E. 50 - 60 - 70 mm. Galvanized finishing.

2001  
SEMPLICE



Codice Code	Entrata Entrance	Mandate Turns	Corsa Stroke				
200150	50	2	20	2 CV2000	2 PI2000	CP2001	25
200160	60	4	40	2 CV2000	2 PI2000	CP2001	20
200170	70	4	40	2 CV2000	2 PI2000	CP2001	20

Serratura triplice a doppia mappa per serramenti e cancelletti. E. 50 - 60 - 70 mm. Finitura zincata.

Three locking points double ward lock for frames and gates. E. 50 - 60 - 70 mm. Galvanized finishing.





2003  
TRIPLICE

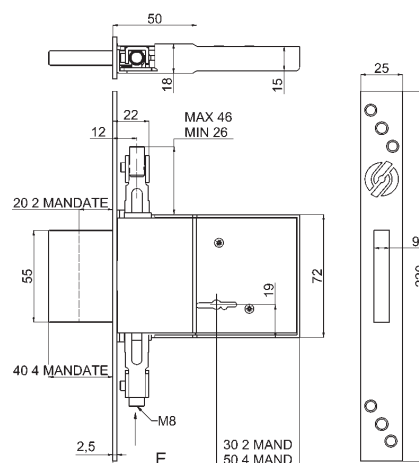
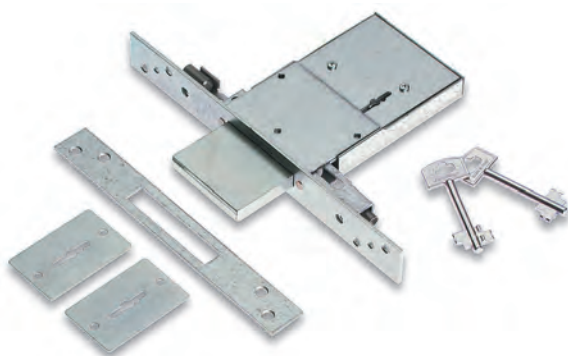

**OPTIONAL**  
2 aste art. AA1. (pag. 172)

**OPTIONAL**  
2 rods art. AA1. (page 172)



Codice Code	Entrata Entrance	Mandate Turns	Corsa Stroke				
200350	50	2	20	2 CV2000	2 PI2000	CP2001	25
200355	60	2	20	2 CV2000	2 PI2000	CP2001	20
200360	60	4	40	2 CV2000	2 PI2000	CP2001	20
200370	70	4	40	2 CV2000	2 PI2000	CP2001	20

## SERRATURE AD INFILARE | MORTICE LOCKS

### 2011

Serratura laterale a doppia mappa per serramenti e cancelletti con catenaccio a pistoni. Finitura zincata.

Lateral double ward lock for frames and gates with pistons bolt. Galvanized finishing.

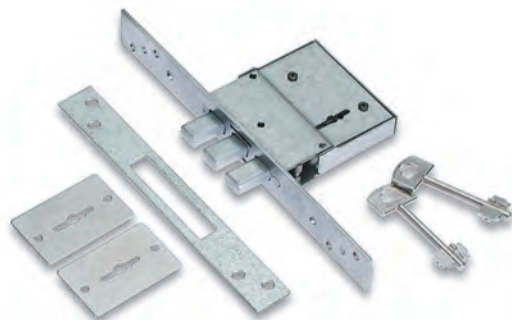
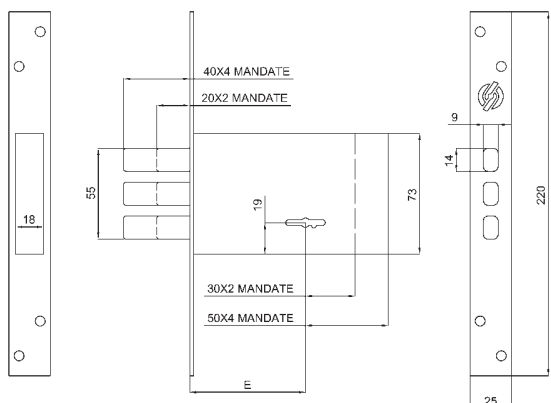

Codice Code	Entrata Entrance	Mandate Turns	Corsa Stroke				
201150	50	2	20	2 CV2000	2 PI2000	CP2001	25
201160	60	4	40	2 CV2000	2 PI2000	CP2001	20
201170	70	4	40	2 CV2000	2 PI2000	CP2001	20

### 2013

Serratura triplice a doppia mappa per serramenti e cancelletti con catenaccio a pistoni. Finitura zincata.

Three locking points double ward lock for frames and gates with pistons bolts. Galvanized finishing.

**OPTIONAL**  
2 aste art. AA1. (pag. 172)

**OPTIONAL**  
2 rods art. AA1. (page 172)

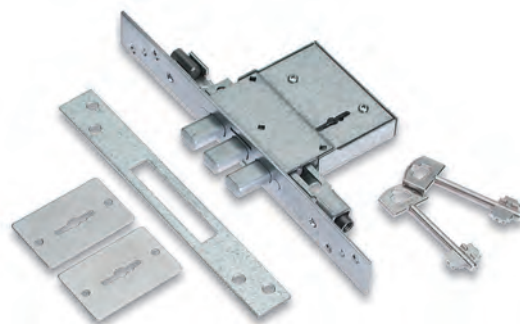
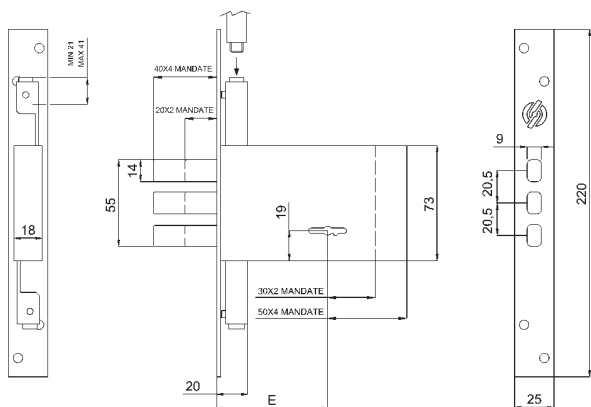

Codice Code	Entrata Entrance	Mandate Turns	Corsa Stroke				
201350	50	2	20	2 CV2000	2 PI2000	CP2001	25
201360	60	4	40	2 CV2000	2 PI2000	CP2001	20
201370	70	4	40	2 CV2000	2 PI2000	CP2001	20

Serratura laterale a doppia mappa per serramenti e cancelletti con scrocco reversibile e catenaccio. Finitura zincata.

Lateral double ward lock for frames and gates with reversible latch and bolt. Galvanized finishing.

2010



**OPTIONAL**  
Contropiastra art. CP2008. (pag. 173)

**OPTIONAL**  
Striking plates art. CP2008. (page 173)

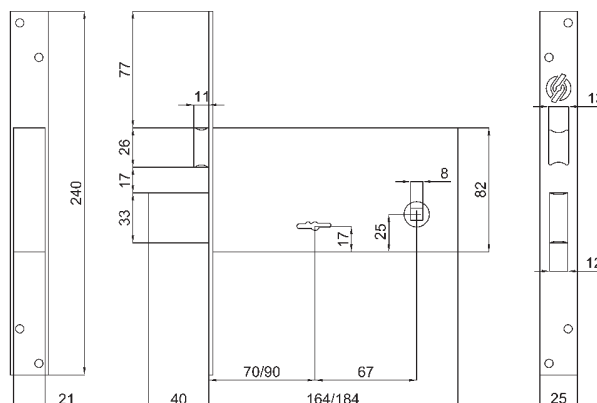

Codice Code	Entrata Entrance	Mandate Turns	Corsa Stroke			
201070	70	4	40	3 CV2000	2 PI2000	15
201090	90	4	40	3 CV2000	2 PI2000	15

Serratura triplice a doppia mappa per serramenti e cancelletti con scrocco reversibile e catenaccio. Finitura zincata.

Three locking points double ward lock for frames and gates with reversible latch and bolt. Galvanized finishing.

2008



**OPTIONAL**  
2 aste art. AA1. (pag. 172)  
Contropiastra art. CP2008. (pag. 173)

**OPTIONAL**  
2 rods art. AA1. (page 172)  
Striking plates art. CP2008. (page 173)

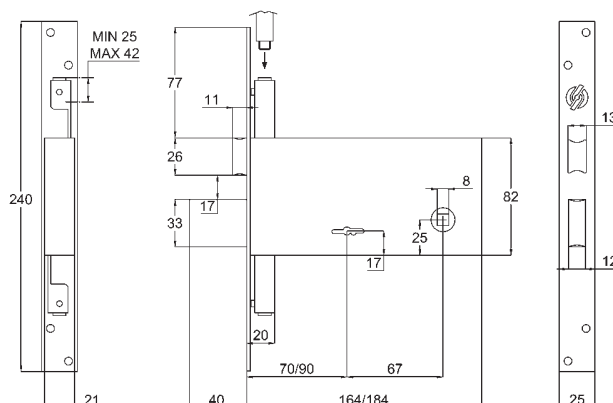

Codice Code	Entrata Entrance	Mandate Turns	Corsa Stroke			
200870	70	4	40	3 CV2000	2 PI2000	15
200890	90	4	40	3 CV2000	2 PI2000	15





## SERRATURE AD INFILARE | MORTICE LOCKS

### 2000 SIMPLEX

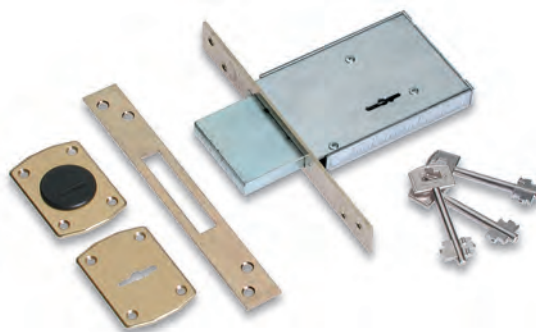
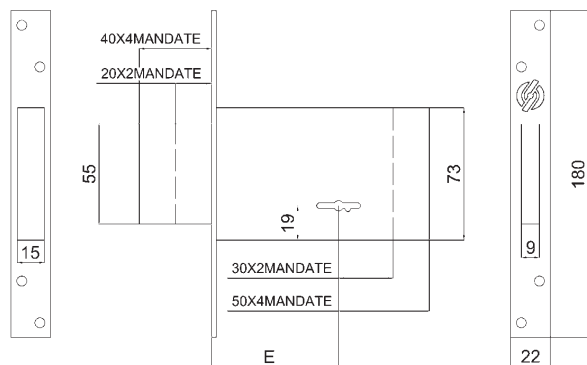
Serratura laterale a doppia mappa per serramenti. E. 40 - 50 - 60 - 70 mm.  
Finitura zincata.

*Lateral double ward lock for frames.  
E. 40 - 50 - 60 - 70 mm.  
Galvanized finishing.*







Codice Code	Entrata Entrance	Mandate Turns	Corsa Stroke				
200040	40	2	20	3 CV2000	PI2020	CP2000	25
200050	50	4	40	3 CV2000	PI2020	CP2000	25
200060	60	4	40	3 CV2000	PI2020	CP2000	25
200070	70	4	40	3 CV2000	PI2020	CP2000	25

### 2020 SUITE

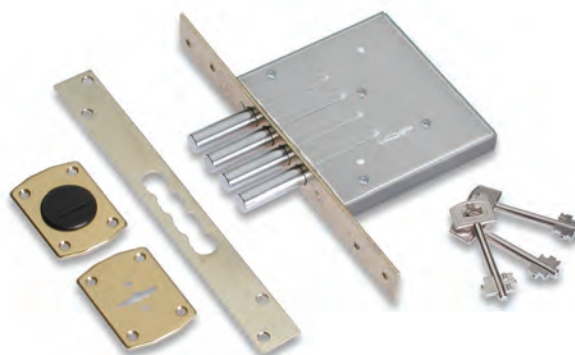
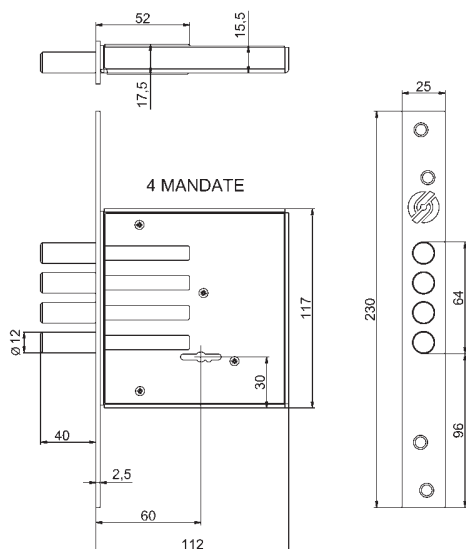
Serratura laterale a doppia mappa per serramenti con 4 pistoni. E. 60 mm.

*Lateral double ward lock for frames with  
4 pistons. E. 60 mm.*







Codice Code	Entrata Entrance	Mandate Turns	Corsa Stroke	Finitura Finishing				
2020	60	4	40	OT	3 CV2000	PI2020	CP2020	12
2020C5	60	4	40	OT	5 CV2000	PI2020	CP2020	12
20202L	60	4	40	CR	3 CV2000	PI2022L	CP2020L	12
2020C52L	60	4	40	CR	5 CV2000	PI2022L	CP2020L	12

Serratura laterale a doppia mappa per serramenti con 4 pistoni.  
Lunghezza frontale 240 mm. E. 40 mm.

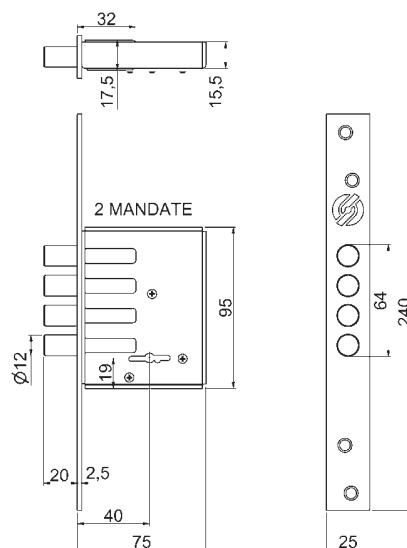
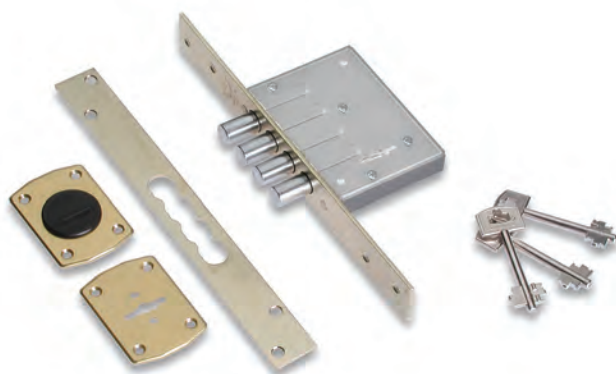
Lateral double ward lock for frames with 4 pistons. Frontal length 240 mm. E. 40 mm.

2025







Codice Code	Entrata Entrance	Mandate Turns	Corsa Stroke	F	Finitura Finishing				
2025	40	2	20	240	OT	3 CV2000	PI2020	CP2020	12
2025C5	40	2	20	240	OT	5 CV2000	PI2020	CP2020	12
20252L	40	2	20	240	CR	3 CV2000	PI2022L	CP20202L	12
2025C52L	40	2	20	240	CR	5 CV2000	PI2022L	CP20202L	12

Serratura laterale a doppia mappa per serramenti con 4 pistoni.  
Lunghezza frontale 180 mm. E. 40 mm.

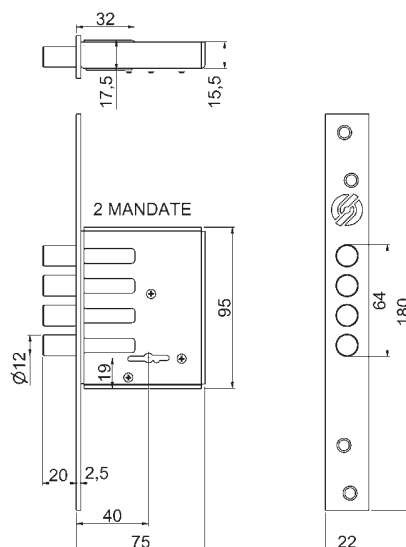
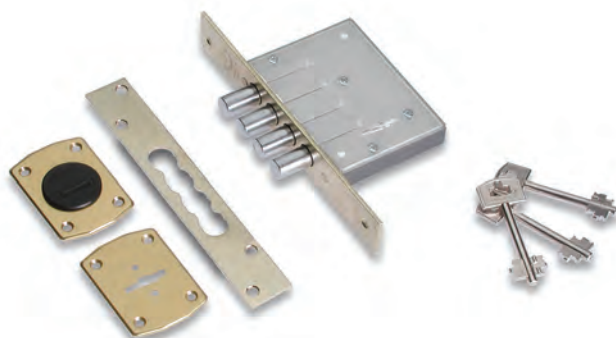
Lateral double ward lock for frames with 4 pistons. Frontal length 180 mm. E. 40 mm.

2025 /180



Codice Code	Entrata Entrance	Mandate Turns	Corsa Stroke	F	Finitura Finishing				
2025/180	40	2	20	180	OT	3 CV2000	PI2020	CP2025	25
2025C5/180	40	2	20	180	OT	5 CV2000	PI2020	CP2025	25





## SERRATURE AD INFILARE | MORTICE LOCKS

### 2028

Serratura laterale a doppia mappa per serramenti con 4 pistoni. E. 50 mm.

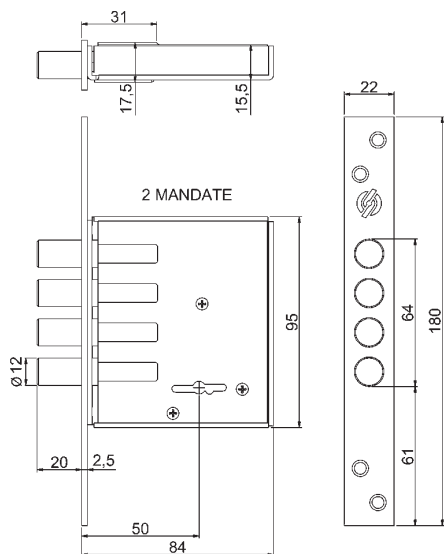
Lateral double ward lock for frames with 4 pistons. E. 50 mm.







Code Code	Entrata Entrance	Mandate Turns	Corsa Stroke	Finitura Finishing				
<b>2028</b>	50	2	20	OT	3 CV2000	PI2020	CP2025	25
<b>2028C5</b>	50	2	20	OT	5 CV2000	PI2020	CP2025	25
<b>20282L</b>	50	2	20	CR	3 CV2000	PI2022L	CP20252L	25
<b>2028C52L</b>	50	2	20	CR	5 CV2000	PI2022L	CP20252L	25

### 2029

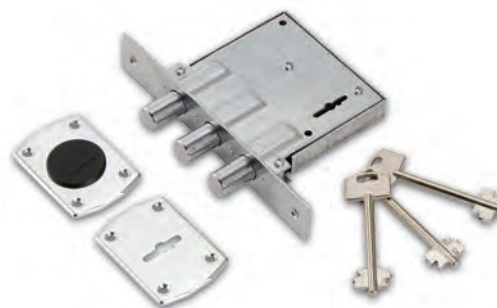
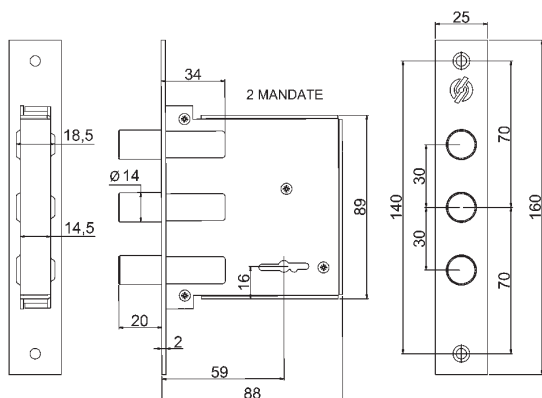
Serratura laterale a doppia mappa per serramenti a 3 pistoni. E. 60 mm.

Lateral double ward lock for frames with 3 pistons. E. 60 mm



Code Code	Entrata Entrance	Mandate Turns	Corsa Stroke	Finitura Finishing			
<b>2029</b>	60	2	20	CR	2 CV2000	2 PI2020	25
<b>2029L</b>	60	2	20	CR	2 CV2000	2 PI2022L	25
<b>2029C5</b>	60	2	20	CR	5 CV2000	2 PI2020	25
<b>2029C52L</b>	50	2	20	CR	5 CV2000	2 PI2022L	25





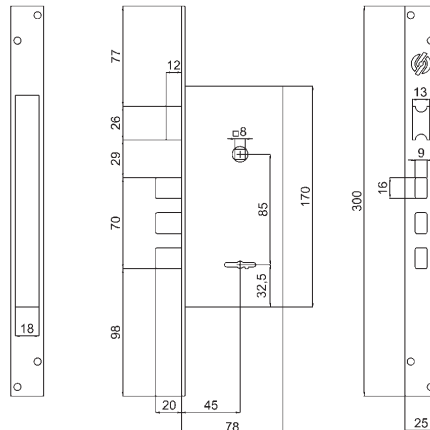
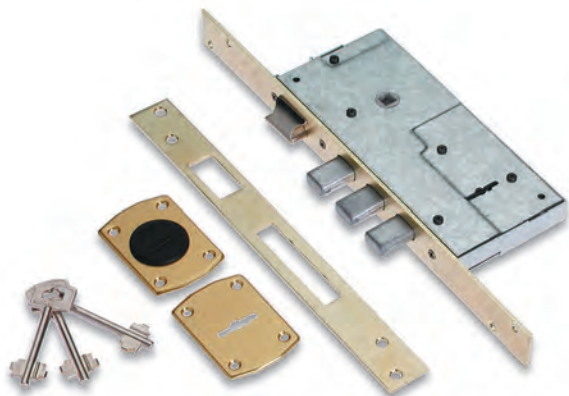

Serratura laterale a doppia mappa per serramenti con catenaccio e scrocco reversibile. E. 45 mm. Quadro maniglia 8 mm. Interasse 85 mm.

Lateral double ward lock for frames with bolt and reversible latch. E. 45 mm. Square handle 8 mm. Interspace 85 mm.

2017



Codice Code	Entrata Entrance	Mandate Turns	Corsa Stroke	Finitura Finishing				
2017	45	2	20	OT	3 CV2000	PI2020	CP2017	10
2017C5	45	2	20	OT	5 CV2000	PI2020	CP2017	10
20172L	45	2	20	CR	3 CV2000	PI2022L	CP20172L	10
2017C52L	45	2	20	CR	5 CV2000	PI2022L	CP20172L	10

Serratura triplice a doppia mappa per serramenti con catenaccio e scrocco reversibile. E. 45 mm. Quadro maniglia 8 mm. Interasse 85 mm.

Three locking points double ward lock for frames with bolt and reversible latch. E. 45 mm. Square handle 8 mm. Interspace 85 mm.





2018

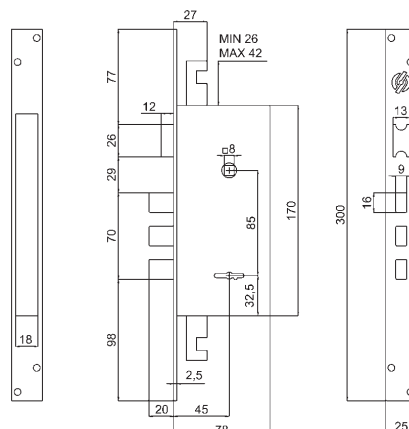
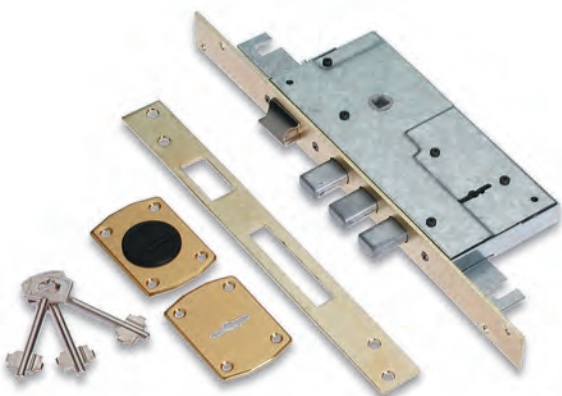

**OPTIONAL**  
2 aste art. AA2. (pag. 172)

**OPTIONAL**  
2 rods art. AA2. (page 172)



Codice Code	Entrata Entrance	Mandate Turns	Corsa Stroke	Finitura Finishing				
2018	45	2	20	OT	3 CV2000	PI2020	CP2017	10
2018C5	45	2	20	OT	5 CV2000	PI2020	CP2017	10
20182L	45	2	20	CR	3 CV2000	PI2022L	CP20172L	10
2018C52L	45	2	20	CR	5 CV2000	PI2022L	CP20172L	10





## SERRATURE AD INFILARE | MORTICE LOCKS

### 2021

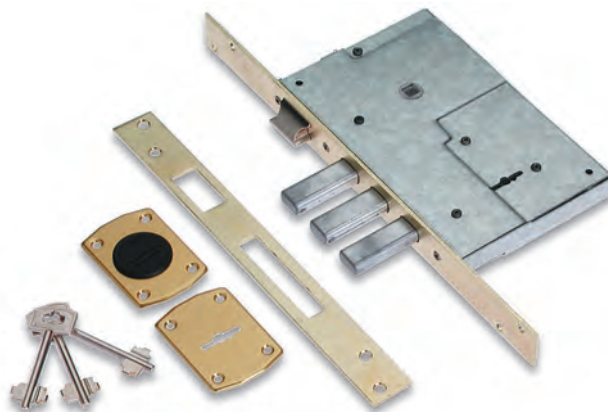
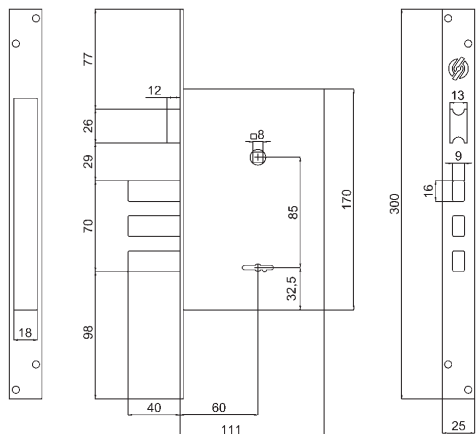
Serratura laterale a doppia mappa per serramenti con catenaccio a pistoni e scrocco reversibile. E. 60 mm. Quadro maniglia 8 mm. Interasse 85 mm.

*Lateral double ward lock for frames with bolt and reversible latch. E. 60 mm. Square handle 8 mm. Interspace 85 mm.*



Codice Code	Entrata Entrance	Mandate Turns	Corsa Stroke	Finitura Finishing				
2021	60	4	40	OT	3 CV2000	PI2020	CP2017	10
2021C5	60	4	40	OT	5 CV2000	PI2020	CP2017	10

### 2022



Serratura triplice a doppia mappa per serramenti con catenaccio e scrocco reversibile. E. 60 mm. Quadro maniglia 8 mm. Interasse 85 mm.

*Three locking points double ward lock for frames with bolt and reversible latch. E. 60 mm. Square handle 8 mm. Interspace 85 mm.*

**OPTIONAL**  
2 aste art. AA2. (pag. 172)

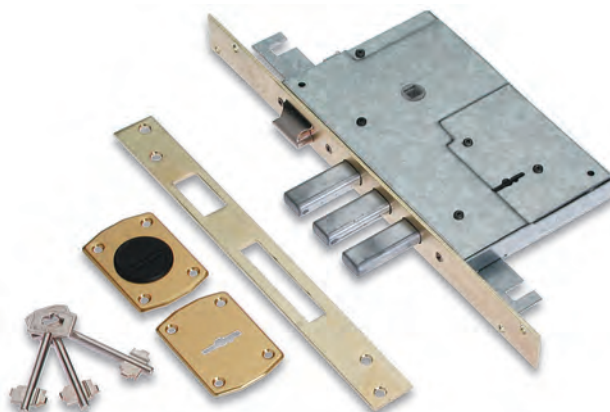
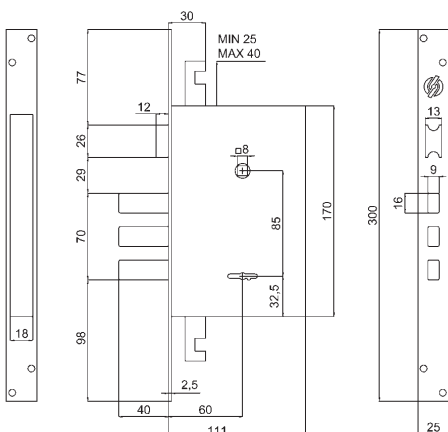
**OPTIONAL**  
2 rods art. AA2. (page 172)



Codice Code	Entrata Entrance	Mandate Turns	Corsa Stroke	Finitura Finishing				
2022	60	4	40	OT	3 CV2000	PI2020	CP2017	10
2022C5	60	4	40	OT	5 CV2000	PI2020	CP2017	10